

RAYCHEM TraceTek

TT1000

Modular Sensing Cable Installation Instructions

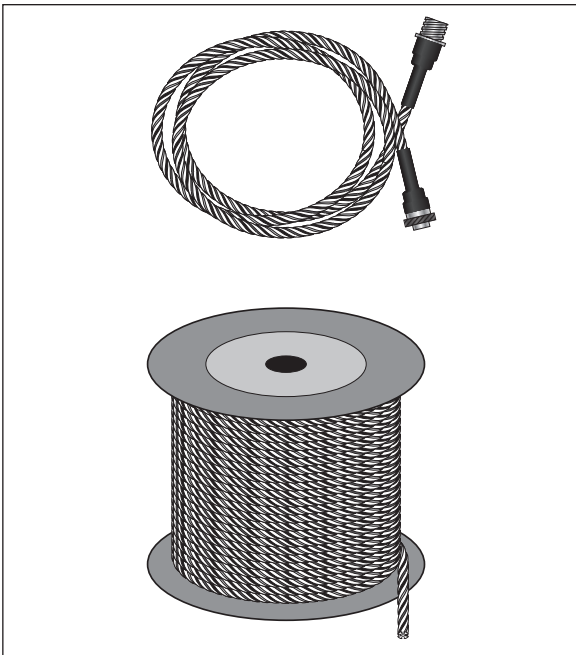

GENERAL INFORMATION

These instructions explain the proper procedures for installing and testing nVent RAYCHEM TraceTek TT1000 modular sensing cables, and provide specifics for sumps, subflooring, and trenches.

Use these instructions with the General Installation Instructions for TraceTek Leak Detection Systems in Commercial Buildings (H55522). That document provides an overview of the installation process for the TraceTek system, and refers to detailed instructions (as applicable) for each step.

To obtain copies of installation instructions, consult nVent at (650) 216-1526.

TOOLS AND MATERIALS FOR INSTALLATION AND TESTING

- TT-PTB-1000 Portable Test Box with adapters or ohmmeter (20 M Ω range or greater).
- TT-MLC-PC Modular Leader Cable (needed for testing with ohmmeter).
- TT-MET-PC Modular End Termination.
- TT-HDC-1/4 (with adhesive pressure-sensitive backing) **or** TT-HDC-1/4-200-NA Hold Down-Clips and (obtained locally) 3M-type 1300 or 08001 adhesive.

COMPLETE BILL OF MATERIALS

Before beginning installation, confirm there is a plan for the leak detection system layout, and a complete bill of materials. In addition to sensing cables, the leak detection bill of materials should include a TraceTek alarm.

Module, leader and/or jumper cables, mapping tags (TT-TAG), and various other components, such as modular branching connectors (TT-MBC-PC).

General Notes—Do's and Don'ts

Do

- Store the sensing cable in its original container in a clean, dry area prior to installation.
- Schedule sensing cable installation after major construction work (which could damage or contaminate the cable) has been completed.
- Clean the area where sensing cable is to be installed and remove any debris or other source of contamination.

Don't

- Drag sensing cable through contaminants (such as pipe dope, PVC cement, solvents, oil, or dirt).
- Use damaged or contaminated sensing cable.
- Solder or weld near the cable without protecting it from heat, flux, and splatter.
- Drop tools or sharp or heavy objects onto the cable.
- Pull the sensing cable with excessive force (more than 50 pounds/20 kg).
- Use adhesive tapes or clamping devices to secure the sensing cable.
- Allow cable connectors to become wet, dirty, or contaminated.

General Layout of TraceTek System

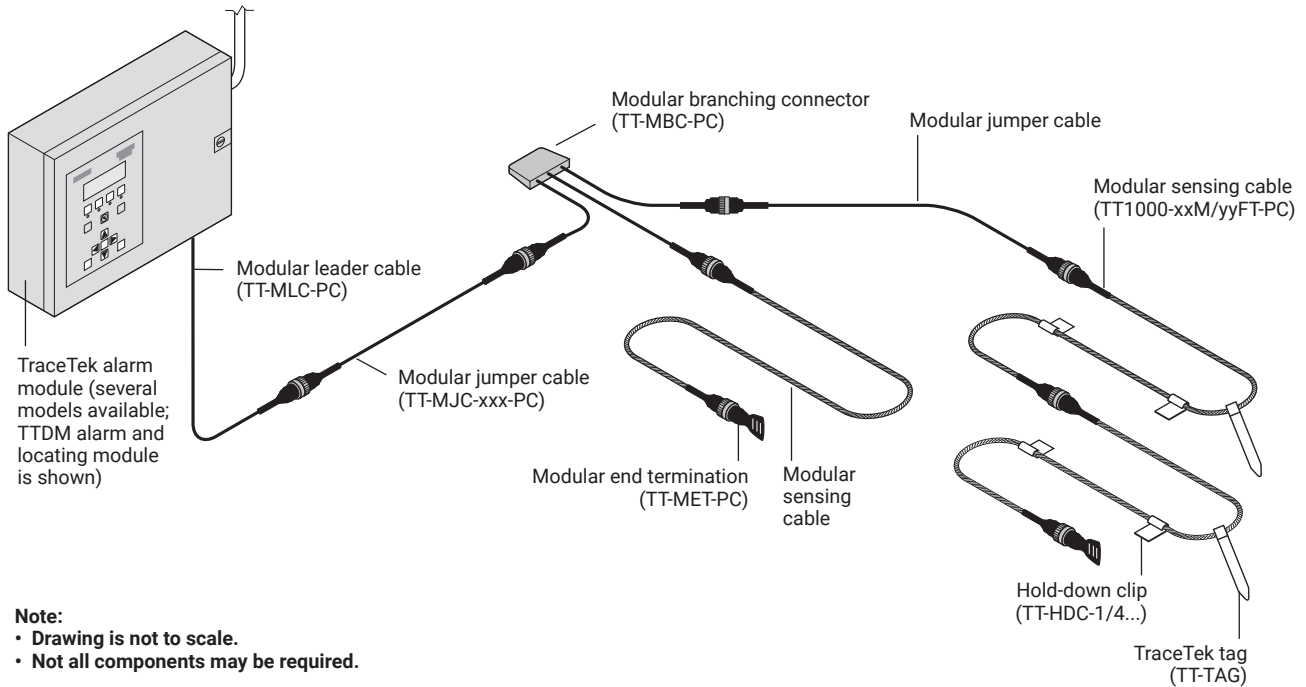

Installation Steps

1. Prepare the area where the sensing cable will be located.

- Verify that major construction is complete.
- Clean the area where the cable will be installed, to remove debris and sources of contamination.
- Install TraceTek hold-down clips. For TraceTek TT1000 sensing cables, use 1/4 inch hold-down clips (TT-HDC-1/4...).

Clean the floor surface where hold-down clips will be placed, so adhesive can work properly.

Position hold-down clips so the sensing cable will provide the desired leak-detection coverage. To best secure the cable, alternate the direction of the hold-down clips, and install them at intervals of no greater than 6 feet (2 m) and at every change in direction.

Important: Let the adhesive dry per the manufacturer's recommendation before proceeding with sensing cable installation.

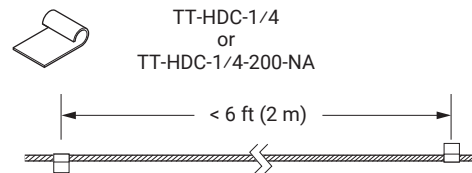

2. Check each length of sensing cable before installation.

To ensure that each length of sensing cable is intact and free of contamination, follow the "Sensing Cable Test Procedure" on page 5. Do not use damaged or contaminated sensing cable.

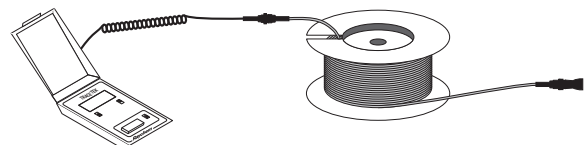

3. Observe proper precautions when handling sensing cables.

Observe the do's and don'ts printed on page 1 of these instructions; take care to avoid damaging or contaminating sensing cable.



4. Connect, orient, install, and test each length of sensing cable in sequence.

1. **Connect** a Modular End Termination (TT-MET-PC) to the first sensing cable length to be installed.
2. **Orient** sensing cable so end termination will be away from connection to the TraceTek alarm module. Work outward from the alarm module connection. To help dispense sensing cable on reels (lengths over 10 feet/3 meters), put the reel on an axle.
3. **Install** sensing cable in accordance with the engineer's leak detection layout plan.

Pull the cable alongside the installed hold-down clips. Leave 6 inches (150 mm) of sensing cable on each end for the connector service loop.

Important: Verify that the adhesive securing the hold-down clips has dried; liquid adhesive must not contact the cable.

Push sensing cable into the hold-down clips and position the sensing cable to lay flat on the surface to be monitored.

4. **Test** each length of sensing cable after installing it and before attaching it to cable already installed. Confirm that the sensing cable is clean and intact by following the "Sensing Cable Test Procedure" on page 5.
5. **Connect** the sensing cable to the cable string (lengths of sensing cables connected in series) previously installed.
 - Leave a service loop at each connector as shown.
 - Mark the connector position on the layout plan.
 - Install TraceTek mapping tags (TT-TAG).

Note: As an extra precaution on large installations, periodically test the entire cable string to confirm that all installed sensing cable is still clean and intact.

Unplug the end termination from the previous length and connect it to the next length of sensing cable to be installed.

Repeat the installation sequence for each length of cable.

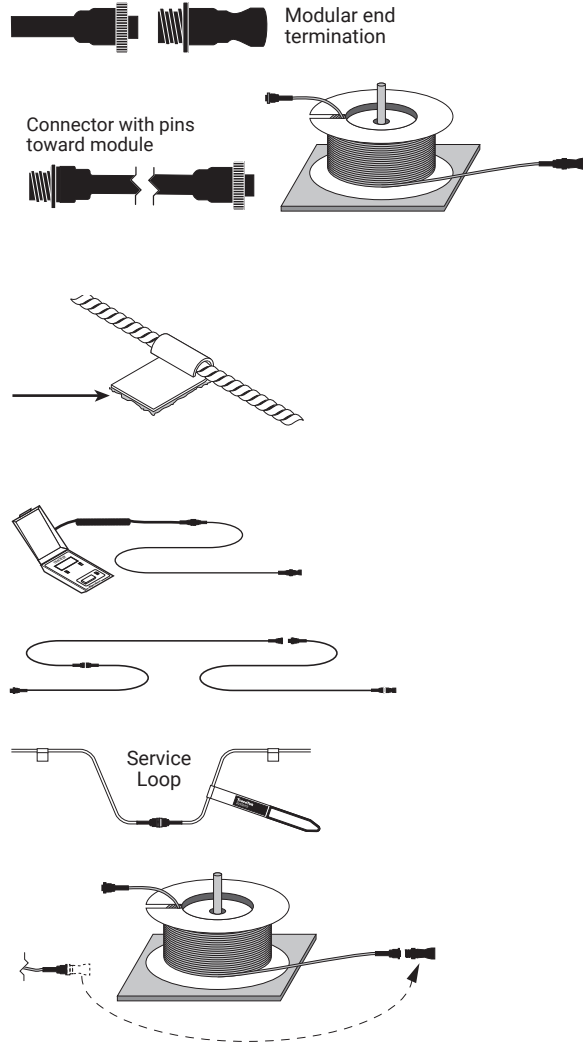

5. Complete the system.

- Install other TraceTek components—for example Modular Branching Connectors, Weighted Lengths, and Modular Jumper Cables—as called for in the system layout. Complete the sensing circuit.
- Test the sensing circuit (or portions of it) to confirm that the sensing cable is clean and intact. Follow the “Sensing Cable Test Procedure” on page 5.
- Connect the sensing circuit to the TraceTek alarm module and activate the system as soon as is practical. Use the module to monitor for events during the final stages of construction.

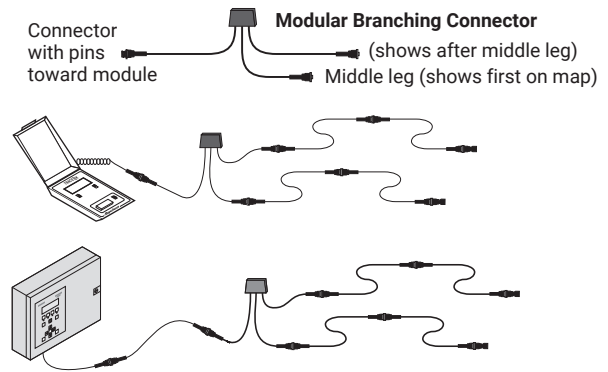

6. Take precautions if installation is incomplete at end of work day.

At the end of the work day:

- Ensure that there are no exposed connectors. Each sensing cable should be connected to a Modular Leader Cable (TT-MLC-PC), Modular End Termination (TT-MET-PC), and/or other sensing cables; check both ends of the cable.
- Test and record the condition of installed sensing cable following the “Sensing Cable Test Procedure” on page 5.
- If practical, connect the installed sensing cable to the TraceTek alarm module. Test the system and put it in operation following the alarm module installation instructions.



At the beginning of the next work day:

- Check that the installed sensing cable is clean and intact following the Sensing Cable Test Procedure. Compare results with those obtained at the end of the previous work day. If necessary, investigate and correct problems before proceeding.

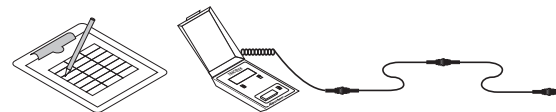

Sensing Cable Test Procedure

Method with TraceTek Portable Test Box (PTB)

1. Ensure the end termination is connected to the sensing cable. If checking several lengths of sensing cable in series (a cable string), ensure they are all connected.
2. Connect the PTB to the sensing cable(s) as illustrated.
3. Verify that the sensing cable is intact; follow the operating instructions printed inside the lid of the PTB itself. If the cable string is intact, the PTB measures the system length (length of TraceTek sensing cable plus the length equivalents of the weighted lengths and modular branching connectors). If a cable or connection is broken, the PTB illuminates its LED indicating "cable break" and displays a "1" in the leftmost position of its LCD display.

If the cable string is not intact, apply this test procedure to segments of the system to identify the open connection or damaged modular length.

4. Check the condition of the sensing cable(s), again following the PTB operating instructions. If the sensing cables are clean and free of contamination, the current measured should be below 10 μ A. If the reading exceeds 10 μ A, use the PTB to locate the liquid or contamination and take appropriate corrective action.

Method with Ohmmeter

1. Ensure the end termination is connected to the sensing cable. If checking several lengths of sensing cable in series (a cable string), ensure they are all connected.
2. Connect a Modular Leader Cable (TT-MLC-PC) to the sensing cable.
3. Verify that the sensing cable is intact
 - Loop 1: Measure the resistance between the yellow and black wires of the leader cable as illustrated.
 - Loop 2: Measure the resistance between the red and green wires of the leader cable.

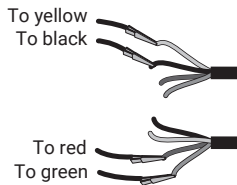

The readings should roughly equal a multiple of the length of sensing cable:

4 times the length of sensing cable (in ft) or
12 times the length of sensing cable (in m)

Example: 4 x 50 ft of cable = 200 Ω ,
12 x 15 m of cable = 180 Ω

In addition, the resistance of the two loops should be within 5 percent of each other.

If the cable string is not intact, apply this test procedure to segments of the system to identify the open connection or damaged modular length.

4. Check the condition of the sensing cable. Measure the resistance between the black and green wires of the leader cable.

If the reading is below 20 M Ω , apply this test procedure to segments of the system to identify the modular sensing cable length(s) affected, then locate the liquid or contamination and take appropriate corrective action.

Testing a string of cables

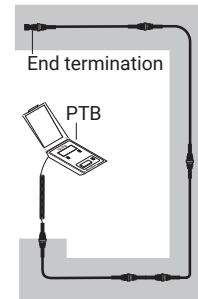

Testing an individual length of cable

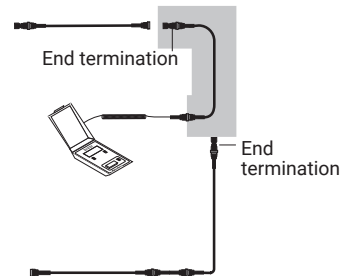

Testing a string of cables

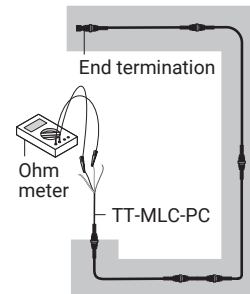

Testing an individual length of cable

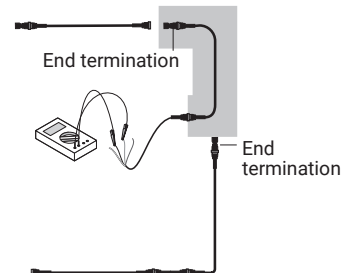

North America

Tel +1.800.545.6258
Fax +1.800.527.5703
thermal.info@nvent.com

Europe, Middle East, Africa

Tel +32.16.213.511
Fax +32.16.213.604
thermal.info@nvent.com

Asia Pacific

Tel +86.21.2412.1688
Fax +86.21.5426.3167
cn.thermal.info@nvent.com

Latin America

Tel +1.713.868.4800
Fax +1.713.868.2333
thermal.info@nvent.com



nVent.com